



Qualität von Anfang an.

## Technische Daten

### BAUFORM

Kompensatoren dienen dem Ausgleich von Verspannungen bei Ausrichtungsfehlern und Rohrleitungsdehnungen sowie bei Vibrationen und Druckschlägen  
Flansch nach EN 1092

### ANSCHLUSS

Gewinde: 1/2" ... 3" - DIN/ISO 228-1  
Flansch: DN32 ... DN300

### BETRIEBSDRUCK

Bis Nenndruck PN10 PN 16

### MINDESTDRUCK

Gewinde 0,5bar absolut  
Flansch 0,7bar absolut

### TEMPERATUR

EPDM -10°C ... +100°C  
NBR -10°C ... +80°C

### WERKSTOFF

Edelstahl  
Stahl verzinkt

### MEDIUM

Wasser  
ungefährliche Gase

### ZULASSUNGEN

WRAS-Zulassung auf Anfrage

### MONTAGEHINWEIS

Installieren Sie das Gelenk nicht in direktem Kontakt mit einer Gummioberfläche.  
Keine Dichtungen zwischen Gelenk und Gegenflansch platzieren.

Alle Angaben sind freibleibend und unverbindlich!

## Specification

### DESIGN

Compensators are used to compensate for tension in alignment errors and pipe expansion as well as vibrations and pressure surges  
Flange with EN 1092

### CONNECTION

Thread: 1/2" ... 3" - DIN/ISO 228-1  
Flange: DN32 ... DN300

### PRESSURE RANGE

Nominal pressure PN 10 PN 16

### MINIMUM PRESSURE

Thread 0,5bar absolute  
Flange 0,7bar absolute

### TEMPERATURE RANGE

EPDM -10°C ... +100°C  
NBR -10°C ... +80°C

### MATERIAL

Stainless steel  
Galvanized steel

### MEDIA

Water  
Non hazardous gases

### APPROVAL

WRAS-approval on request

### ASSEMBLY INSTRUCTION

Do not install the joint in direct contact with a rubber surface.  
Do not place gaskets between the joint and counter flange.

The above information is intended for guidance only and the company reserves the right to change any data herein without prior notice!

Artikel:  
**KP**

Kompensator  
PN 10 PN 16

Edelstahl  
Stahl verzinkt



Type:  
**KP**

Flanged elastomer rubber  
joint  
PN 10 PN 16

Stainless Steel  
Galvanized steel



**Artikel- u. Bestellangaben:** z.B. **KP340007**  
 = Kompensator, Edelstahl/ EPDM, Flansch, DN50

1. + 2. Stelle Produkt	3. + 4. Stelle Werkstoffe / Dichtung	5. + 6. Stelle	7. + 8. Stelle Anschlussgröße	
KP = Kompensator	34 = Edelstahl/ EPDM 52 = Stahl verzinkt/ NBR 54 = Stahl verzinkt/ EPDM	00	<b>Flansch</b>	<b>Gewinde</b>
			05 = DN32	23 = 1/2"
			06 = DN40	24 = 3/4"
			07 = DN50	25 = 1"
			08 = DN65	26 = 1 1/4"
			09 = DN80	27 = 1 1/2"
			10 = DN100	28 = 2"
			11 = DN125	29 = 2 1/2"
			12 = DN150	30 = 3"
			13 = DN200	
			14 = DN250	
			15 = DN300	

**Ordering example:** z.B. **KP340007**  
 = Elastic joint, stainless steel/ EPDM, flanged, DN50

1. + 2. Digit Product	3. + 4. Digit Material / Seal	5. + 6. Digit	7. + 8. Digit Connection	
KP = Elastic joint	34 = stainless steel/ EPDM 52 = galvanized steel/ NBR 54 = galvanized steel/ EPDM	00	<b>Flange</b>	<b>Thread</b>
			05 = DN32	23 = 1/2"
			06 = DN40	24 = 3/4"
			07 = DN50	25 = 1"
			08 = DN65	26 = 1 1/4"
			09 = DN80	27 = 1 1/2"
			10 = DN100	28 = 2"
			11 = DN125	29 = 2 1/2"
			12 = DN150	30 = 3"
			13 = DN200	
			14 = DN250	
			15 = DN300	

**Druck-Temperatur Diagramm Flansch/  
 Pressure-Temperature Diagram flange**

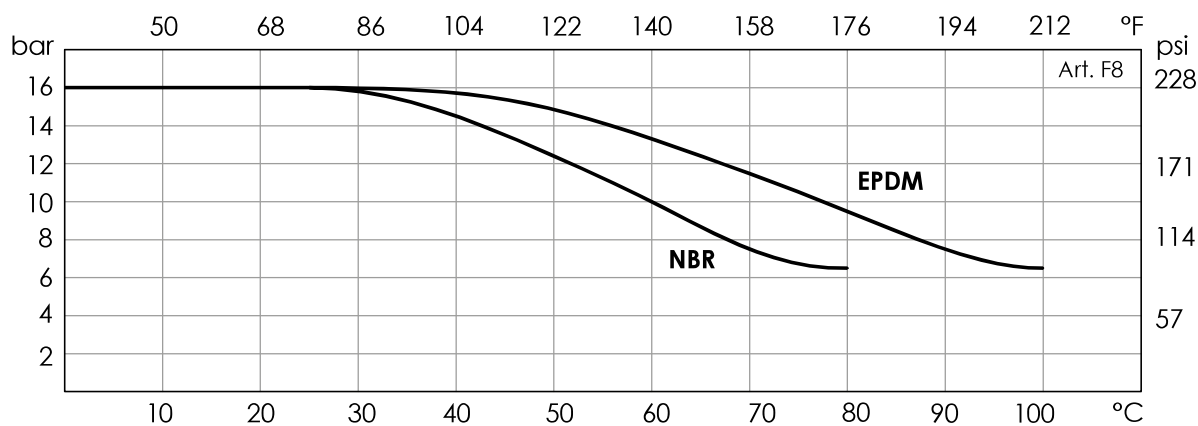

**Druck-Temperatur Diagramm Gewinde/  
 Pressure-Temperature Diagram thread**

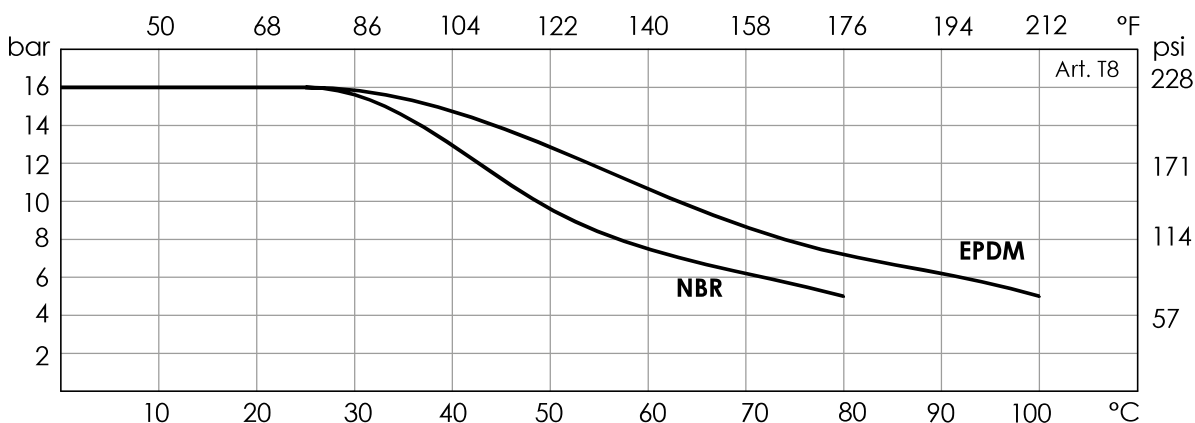

## Abmessungen Flansch / Dimension flange

DN32-150, DN250

DN200

DN300

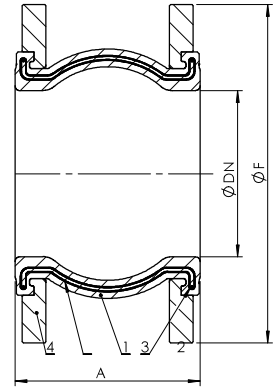
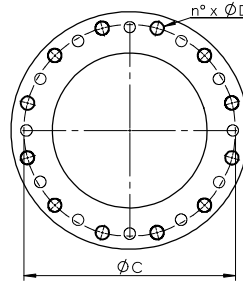
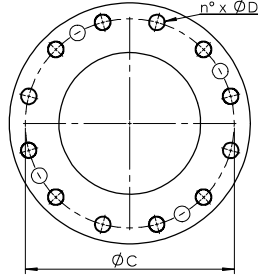
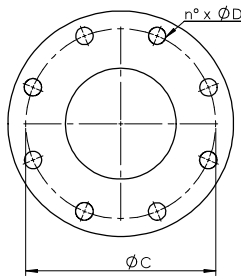

DN	32	40	50	65	80	100	125	150	200	250	300
A	93	93	99	108	116	129	142	156	177	206	217
F	140	150	165	185	200	220	250	285	340	405	460
C	100	110	125	145	160	180	210	240	295	355	410
n x D	4x18	4x18	4x18	4x18	8x18	8x18	8x18	8x22	12x22	12x27	12x26

1. Stauchen Gewinde (mm) / Compression thread (mm)
2. Ausweitung Gewinde (mm) / Extension thread (mm)
3. Verbugung Gewinde (mm), <sup>2</sup>(Grad) / Deflection thread (mm), <sup>2</sup>(angle)

DN	32	40	50	65	80	100	125	150	200	250	300
1	8	8	8	12	12	12	16	16	20	20	20
2	4	4	4	6	6	10	10	10	14	14	14
3	8	8	8	10	10	12	12	12	18	18	18
3 <sup>2</sup>	15	15	15	15	15	15	15	15	15	15	15

## Abmessungen Gewinde / Dimension thread

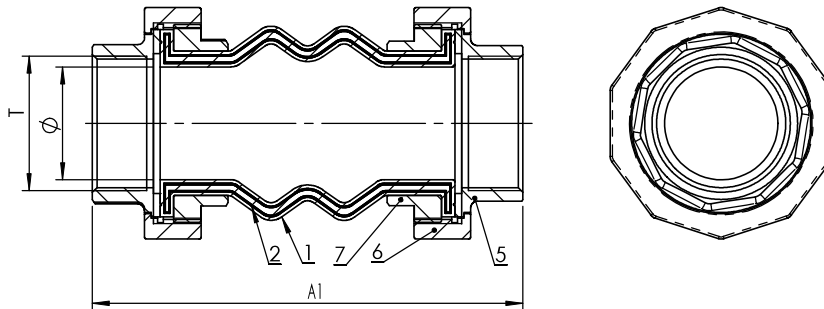

DN	20	25	32	40	50	65	80
T	3/4"	1"	1 1/4"	1 1/2"	2"	2 1/2"	3"
A1	165	175	186	186	200	218	260
P	16	16	21	34	40	54	62

1. Stauchen Gewinde (mm) / Compression thread (mm)
2. Ausweitung Gewinde (mm) / Extension thread (mm)
3. Verbugung Gewinde (mm), <sup>2</sup>(Grad) / Deflection thread (mm), <sup>2</sup>(angle)

DN	20	25	32	40	50	65	80
1	22	22	22	22	22	22	22
2	6	6	6	6	6	6	6
3	22	22	22	22	22	22	22
3 <sup>2</sup>	30	30	30	30	20	15	15



## Druckverlust Flansch / Head loss flange

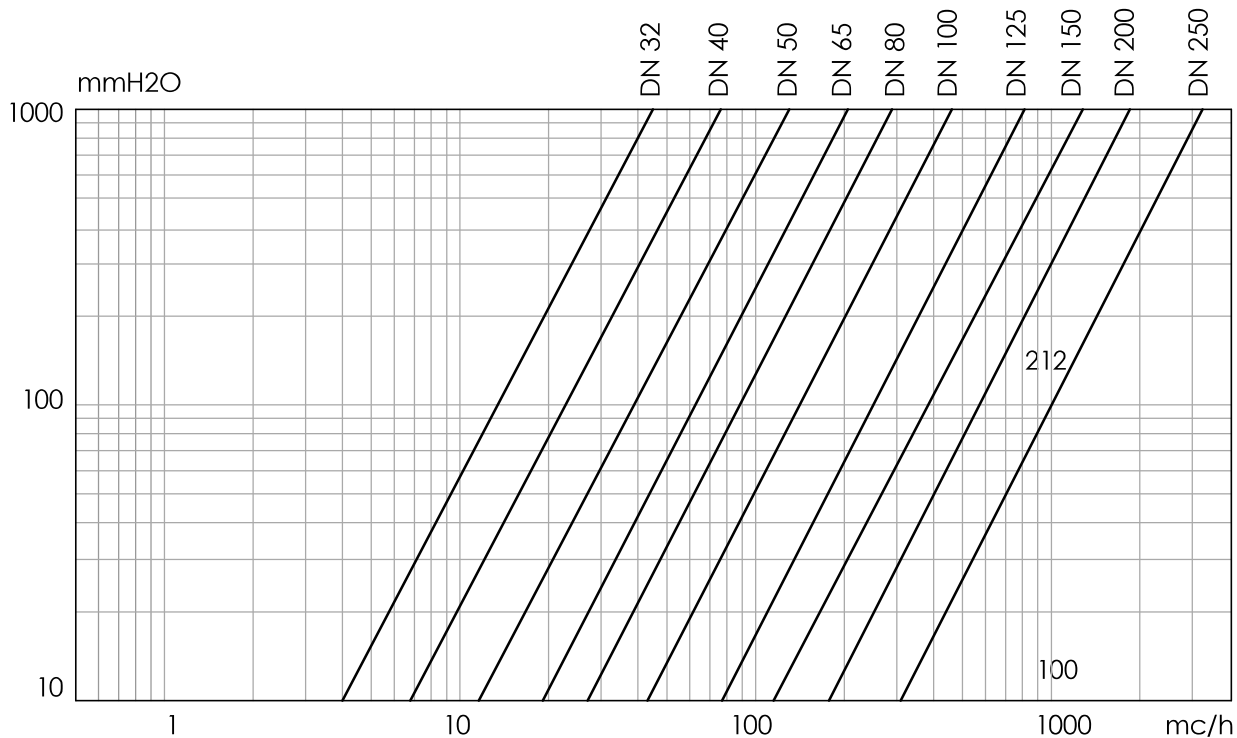

DN	32	40	50	65	80	100	125	150	200	250	300
Kv mc/h	150,4	255	435	672	947	1508	2633	4261	5957	10510	-

## Druckverlust Gewinde / Head loss thread

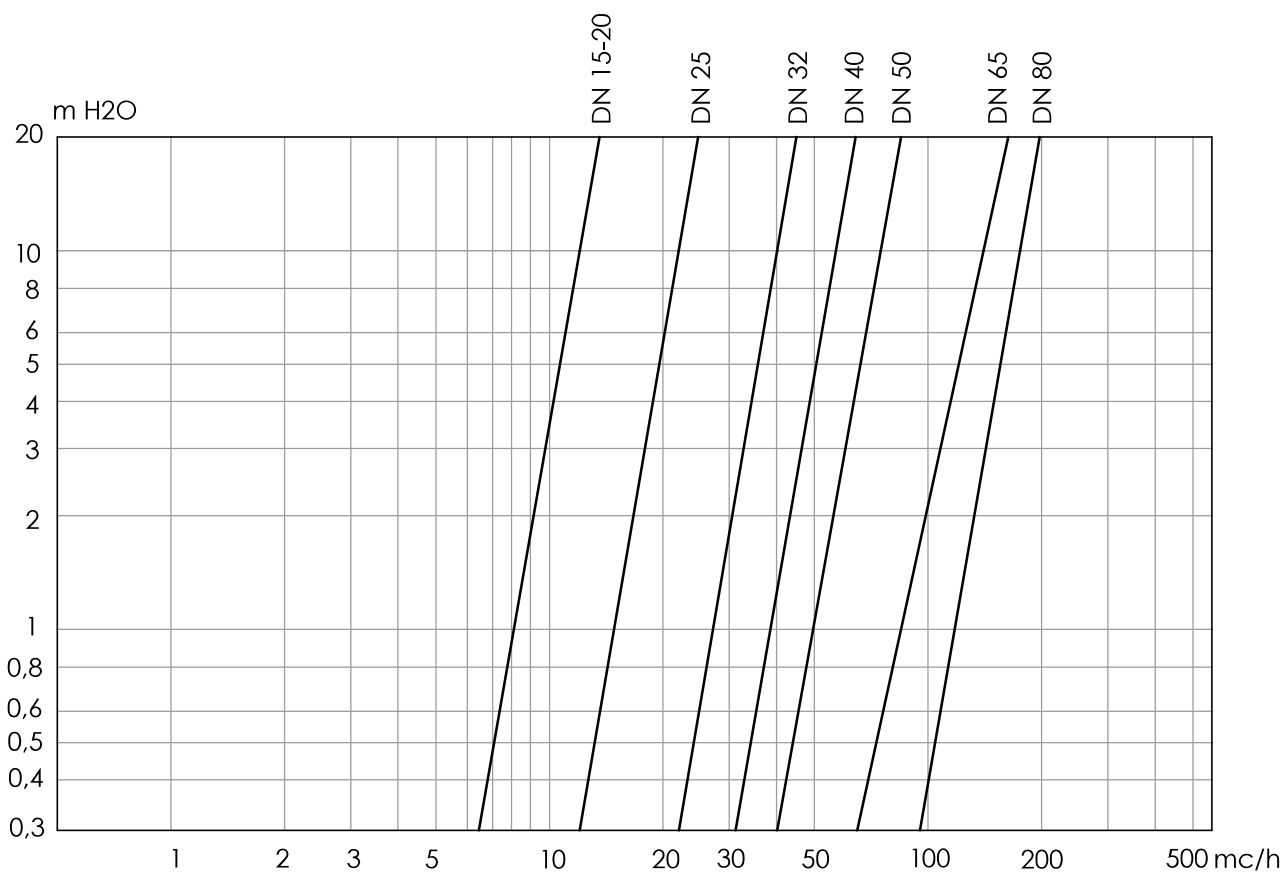

DN	20	25	32	40	50	65	80
Kv mc/h	12	22	40	57	75	140	175

